

VND7050AJ evaluation board

Data brief

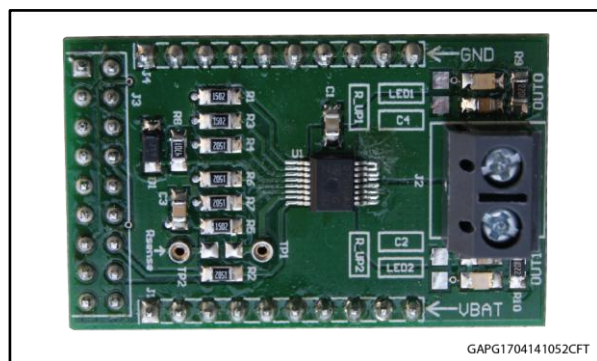

Features

Max transient supply voltage	V_{CC}	40 V
Operating voltage range	V_{CC}	4 to 28 V
Typ. on-state resistance (per Ch)	R_{ON}	50 m Ω
Current limitation (typ)	I_{LIMH}	30 A
Stand-by current (max)	I_{STBY}	0.5 μ A

- Simple single IC application board dedicated for VND7050AJ-E
- Provides electrical connectivity and thermal heat-sinking for easy prototyping
- General device features
 - Double channel smart high-side driver with MultiSense analog feedback
 - Very low standby current
 - Compatible with 3 V and 5 V CMOS outputs
- MultiSense diagnostic functions
 - Multiplexed analog feedback of: load current with high precision proportional

- current mirror, V_{CC} supply voltage and T_{CHIP} device temperature
- Overload and short to ground (power limitation) indication
- Thermal shutdown indication
- OFF-state open-load detection
- Output short to V_{CC} detection
- Sense enable/disable
- Protections
 - Undervoltage shutdown
 - Overvoltage clamp
 - Load current limitation
 - Self limiting of fast thermal transients
 - Configurable latch-off on overtemperature or power limitation with dedicated fault reset pin
 - Loss of ground and loss of V_{CC}
 - Reverse battery with external components
 - Electrostatic discharge protection

Applications

Typical applications are all types of automotive resistive, inductive and capacitive loads.

Description

This board provides you an easy way to connect STMicroelectronics® VIPower® M0-7 technology into your existing system.

Table 1: Device summary

Order code	Reference
EV-VND7050AJ	VND7050AJ evaluation board

1 Overview

The board comes pre-assembled with VND7050AJ-E high-side driver. On board minimum set of electrical components (as for device datasheet recommendation) is enabling the user to directly connect the load, the power supply and the microcontroller without any additional effort in external component design and connection.

The VND7050AJ-E is a double channel high-side driver manufactured using ST proprietary VIPower® technology and housed in PowerSSO-16 package. The device is designed to drive 12 V automotive grounded loads through a 3 V and 5 V CMOS-compatible interface and to provide protection and diagnostics.

The device integrates advanced protective functions such as load current limitation, overload active management by power limitation and overtemperature shutdown with configurable latch-off.

A FaultRST pin unlatches the output in case of fault or disables the latch-off functionality.

A dedicated multifunction multiplexed analog output pin delivers sophisticated diagnostic functions including high precision proportional load current sense, supply voltage feedback and chip temperature sense, in addition to the detection of overload and short circuit to ground, short to V_{CC} and OFF-state open-load. A sense enable pin allows OFF-state diagnosis to be disabled during the module low-power mode as well as external sense resistor sharing among similar devices.

Figure 1: Evaluation board schematic

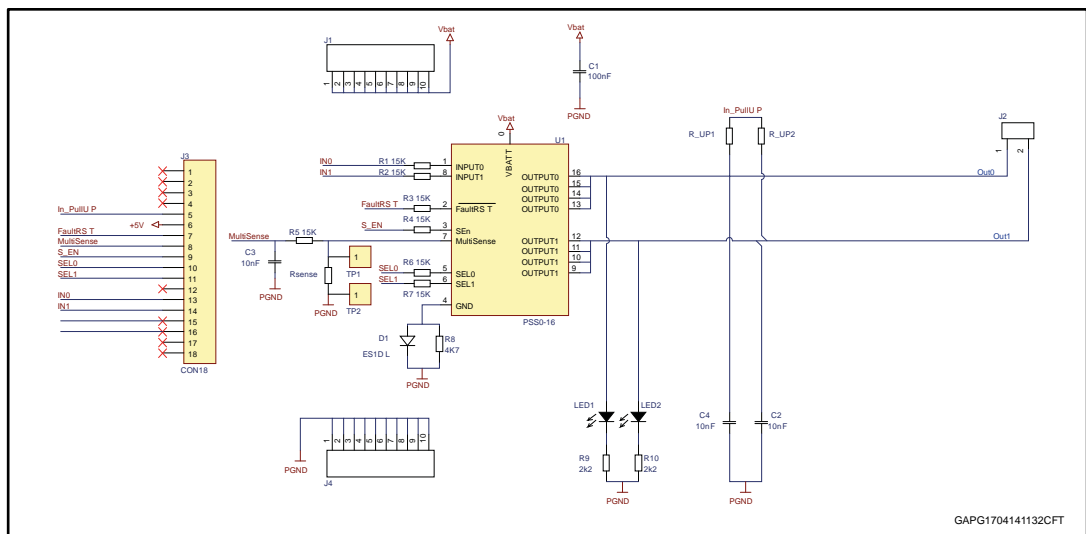

2 Board connections

Figure 2: "Evaluation board connections" shows the placement of the connectors to be used for supplying the evaluation board, connecting the load and controlling the functionality and diagnostic of the device.

Figure 2: Evaluation board connections

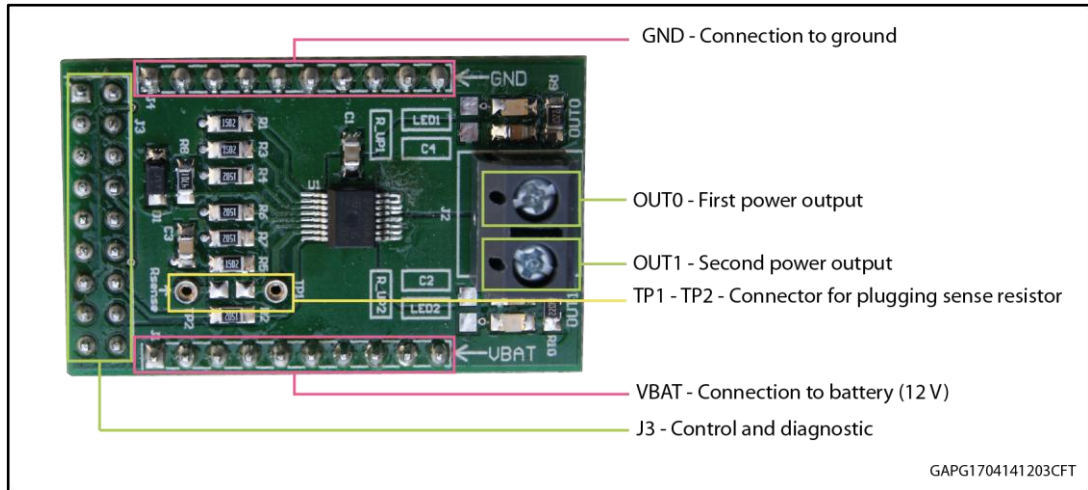

Table 2: J3 connector: pin functions

Connector	Pin number	Pin name	Pin function
J3	1...4	N/A	Not connected
J3	5	IN_PullUP	Connection to optional external pull-up resistor for open load detection in off-state.
J3	6	+5V	5 V Power Supply
J3	7	FaultRST	Active low compatible with 3 V and 5 V CMOS outputs pin; it unlatches the output in case of fault; If kept low, sets the outputs in auto-restart
J3	8	MultiSense	Multiplexed analog sense output pin; it delivers a current proportional to the selected diagnostic: load current, supply voltage or chip temperature
J3	9	S_EN	Active high compatible with 3 V and 5 V CMOS outputs pin; it enables the MultiSense diagnostic pin.
J3	10	SEL0	Active high compatible with 3 V and 5 V CMOS outputs pin; together with SEL1, it addresses the MultiSense multiplexer
J3	11	SEL1	Active high compatible with 3 V and 5 V CMOS outputs pin; together with SEL0, it addresses the MultiSense multiplexer
J3	12	N/A	Not connected
J3	13	IN0	Voltage controlled input pin with hysteresis, compatible with 3 V and 5 V CMOS outputs. It controls OUT0 switch state
J3	14	IN1	Voltage controlled input pin with hysteresis, compatible with 3 V and 5 V CMOS outputs. It controls OUT1 switch state

Connector	Pin number	Pin name	Pin function
J3	15...18	N/A	Not connected

In case the user wishes to utilize the Current Sense/MultiSense function of the device, it is necessary to plug a sense resistor in R_{SENSE} .

The package includes a through-hole resistor, to be mounted on TP1-TP2 (see [Figure 4: "Mounting through-hole sense resistor"](#)).

Different R_{SENSE} values can be adopted based on user preference.

Another option is soldering an SMD resistor on the dedicated PCB pad, as shown in [Figure 5: "Pads for soldering SMD resistor"](#).

Figure 3: No sense resistor



Figure 4: Mounting through-hole sense resistor

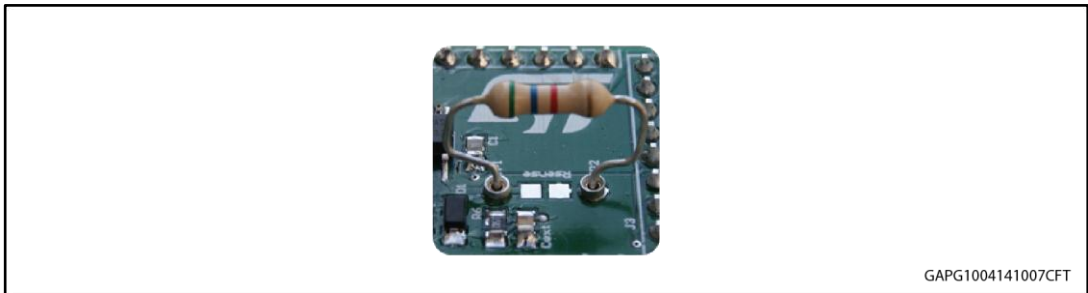

Figure 5: Pads for soldering SMD resistor



3 Thermal data

Table 3: Thermal data

Symbol	Parameter	Max	Unit
$R_{thj-amb}$	Thermal resistance junction-ambient (MAX)	39	°C/W

Table 4: PCB specifications

Parameter	Value
Board dimensions	25 mm x 41.5 mm
Number of Cu layer	2
Layer Cu thickness	35 μ m
Board finish thickness	1.6 mm +/- 10%
Board Material	FR4
Thermal vias separation	1.1 mm
Thermal vias diameter	0.5 mm

4 Revision history

Table 5: Revision history

Date	Revision	Changes
15-May-2014	1	Initial release.
21-Jul-2014	2	Updated Figure 1: "Evaluation board schematic"

IMPORTANT NOTICE – PLEASE READ CAREFULLY

STMicroelectronics NV and its subsidiaries ("ST") reserve the right to make changes, corrections, enhancements, modifications, and improvements to ST products and/or to this document at any time without notice. Purchasers should obtain the latest relevant information on ST products before placing orders. ST products are sold pursuant to ST's terms and conditions of sale in place at the time of order acknowledgement.

Purchasers are solely responsible for the choice, selection, and use of ST products and ST assumes no liability for application assistance or the design of Purchasers' products.

No license, express or implied, to any intellectual property right is granted by ST herein.

Resale of ST products with provisions different from the information set forth herein shall void any warranty granted by ST for such product.

ST and the ST logo are trademarks of ST. All other product or service names are the property of their respective owners.

Information in this document supersedes and replaces information previously supplied in any prior versions of this document.

© 2014 STMicroelectronics – All rights reserved